

Distributed by: BEST MATERIALS LLC, Phoenix AZ
 Ph: 800-474-7570, 602-272-8128, Fax: 602-272-8014
 Email: sales@bestmaterials.com
 www.bestmaterials.com

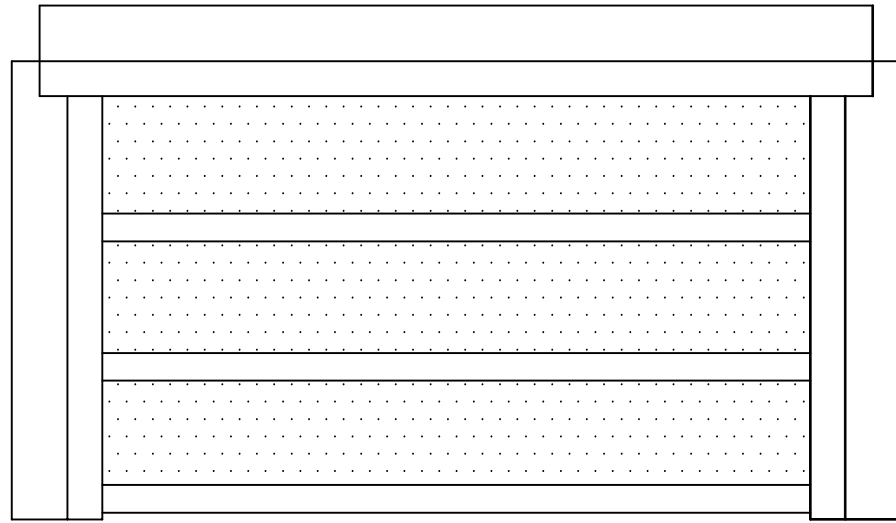

Front Elevation

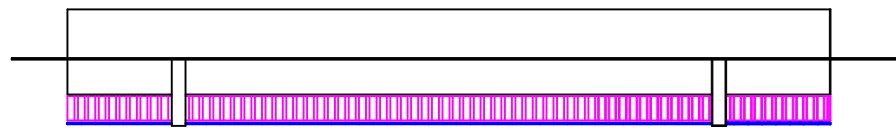

Side Elevation

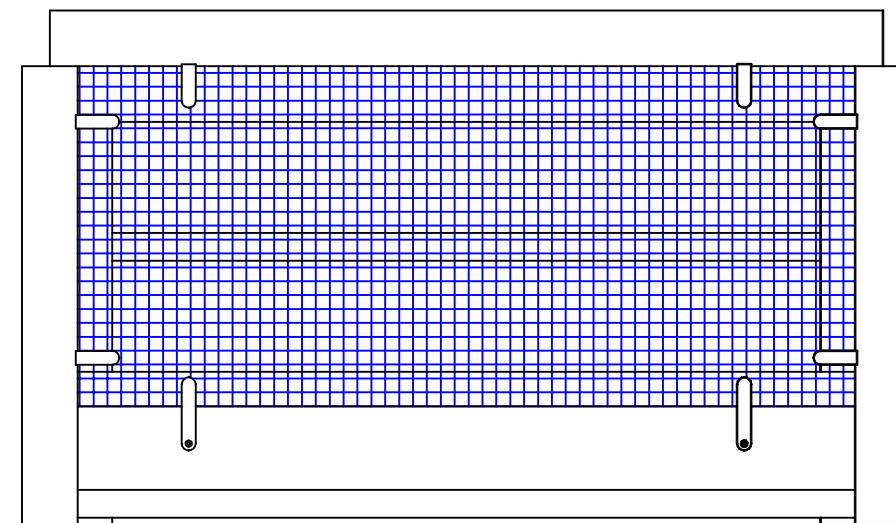

Rear Elevation

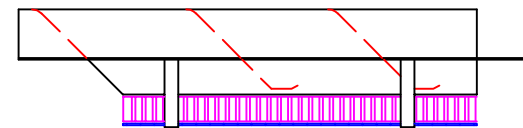

End Elevation

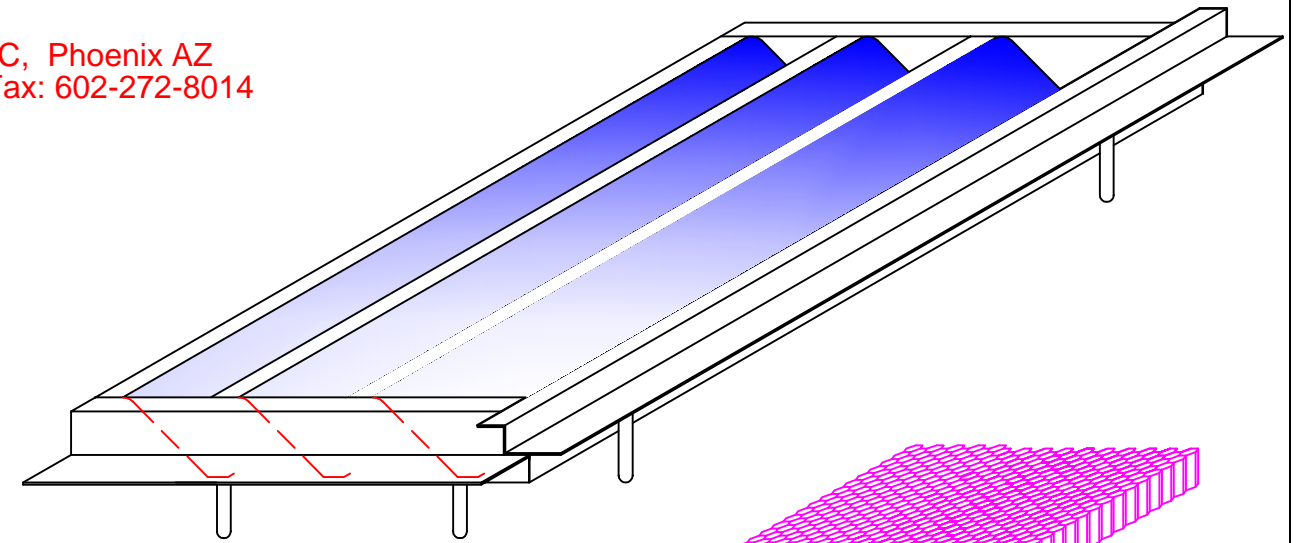

Honeycomb Matrix w/
Intumescent Paint

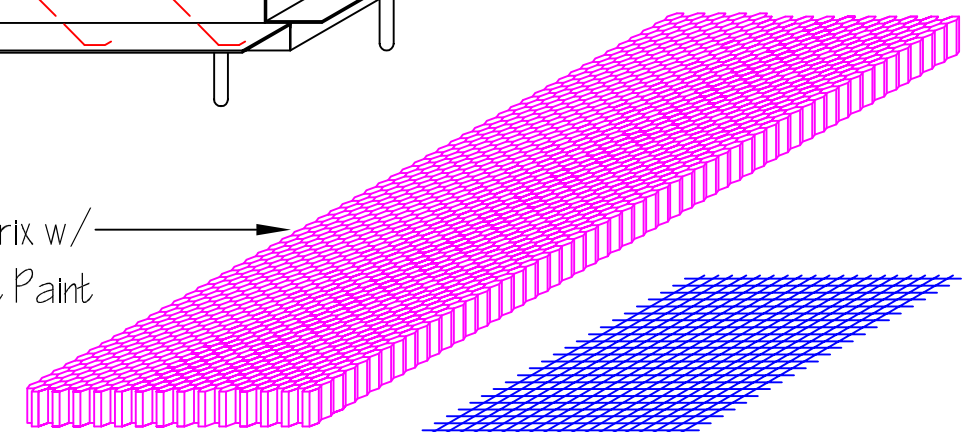

Galvanized Mesh

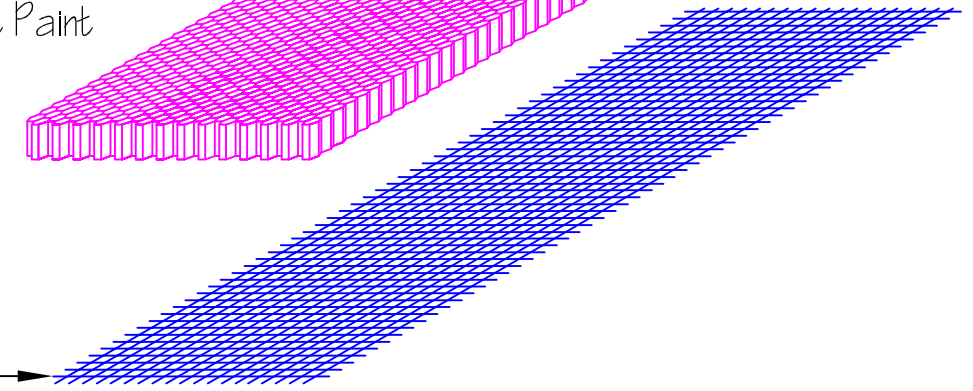

Gable Vent

GMFG#	SIZE	PART
VG148S	14" x 8"	Gable
VG1412S	14" x 12"	Gable
VG1418S	14" x 18"	Gable
VG1424S	14" x 24"	Gable

GUNTER MFG
 Exclusive Producers of:
Vulcan Vents®
 Fire Safe Vents

Stucco Gable Vent